

# LU5

## Signal Tower



LED



85dB at 1m  
(FB type)

Electronic Sound 2  
(FB type)

∅50

IP65

NPN/PNP  
Open collector



## Versatile modular Signal Tower featuring easy assembly and wiring designed for every need.

- PATLITE's Exclusive Hybrid Prism Cut Lens: For enhanced visibility from any direction and distance.
- Built-in Alarms (FB Type): 2 selectable sound patterns up to 85dB at 1m.
- Installation: Direct or pole\* mount.
- Color-coordinated Wiring: Terminal block color corresponds to the lens colors for quick wiring verification.
- Interchangeable LED Modules: No re-wiring even after installation.
- Lens: Superior impact and heat resistant polycarbonate resin for superior durability and light transmission.
- Available Colors: Red, Amber, Green, Blue, Clear/White.
- Conforms to the CE requirements.
- UL Listed (File No. E215660).

### Available By Special Order

- RoHS Compliance.
- Silver Color Body.
- Modules of the same color can be modified to operate from different terminals.

\* Optional part sold separately.

### LED Module



Module Color	Model	Rated Voltage	Operating Voltage	Current/Power	Operating Temperature Range	Mass
RED	LU5-E-R	24V DC	Rated voltage ± 10% (21.6~26.4V)	52mA/1.25W	-30°C~+60°C	44g ±10%
AMBER	LU5-E-Y					
GREEN	LU5-E-G					
BLUE	LU5-E-B					
CLEAR	LU5-E-C					

### How to Order

LED Module		Base Module	
<b>LU5-E-R</b>	Color R: Red Y: Amber G: Green B: Blue C: Clear/White	<b>LU5-02UFB</b>	Rated Voltage 02: 24V DC  Unit color Blank: Ivory White U: Silver color
LED unit	Type Blank: Continuous light FB: Continuous or flashing light with audible alarm		

### Base Module



Model	Options	Rated Voltage	Operating Voltage	Operating Temperature Range	Mass	Open Collector
LU5-02	Continuous Only	24V DC	Rated Voltage ± 10% (21.6~26.4V)	-30°C~+60°C	182g ±10%	PNP/NPN
LU5-02FB	2 Sounds / Flash					

FB type: approx. 60±12 flashes per minute

### Dimensions

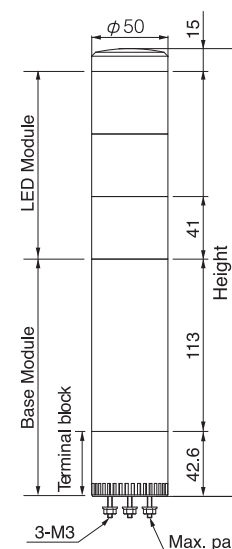

LU5 type

Height (mm)	Number of Lights
211	1 Light
252	2 Lights
293	3 Lights
334	4 Lights
375	5 Lights

### Mounting Dimension

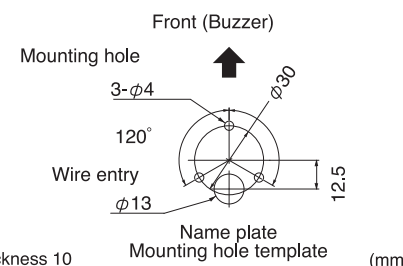

### Wiring Diagram

LU5-02FB  
24V DC

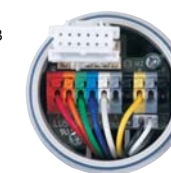

No.	Color	Function
No.1	Red	LED unit Red
No.2	Orange	LED unit Amber
No.3	Green	LED unit Green
No.4	Blue	LED unit Blue
No.5	White	LED unit Clear/White
No.6	Gray	Alarm 1
No.7	Black	Alarm 2
No.8	Yellow	COM
No.9	Gray	Flashing COM
No.10	Black	Power supply for flashing

<Recommended electric wire>  
Solid wire : ∅0.8-∅1.2mm  
Stranded wire : 0.3-1.25mm<sup>2</sup> (AWG 22-18)

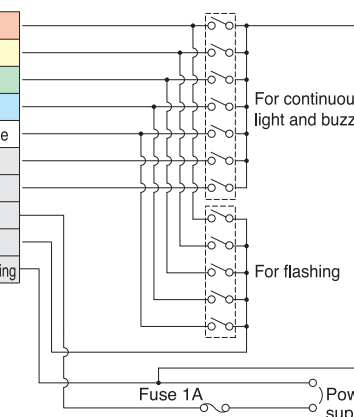

### Optional Parts

#### Upper Bracket

SZ-60-U



Required for pole mounting

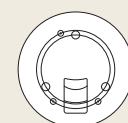

#### Mounting Bracket

SZ-010

(For ∅21.7mm pole)

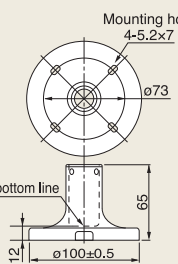

SZ-016A

(For ∅21.7mm pole)

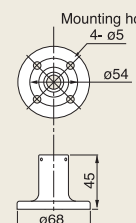

#### Steel Pole

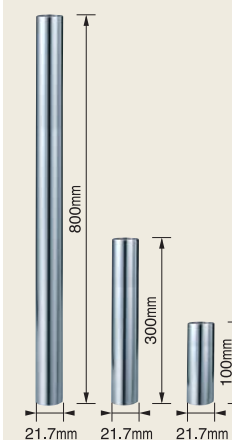

800mm : **POLE-800S21**  
300mm : **POLE-300S21**  
100mm : **POLE-100S21**

#### Aluminum Pole

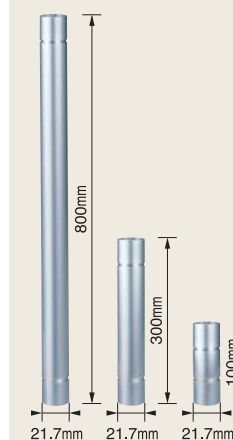

800mm : **POLE-800A21**  
300mm : **POLE-300A21**  
100mm : **POLE-100A21**

#### Wall Mount Bracket

SZ-020

(For ∅21.7mm pole)

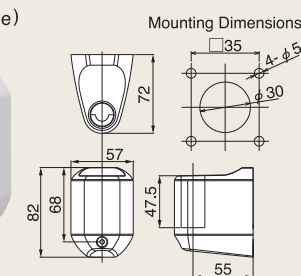

Model	Material
POLE-□□S21	Steel
POLE-□□A21	Aluminum
SZ-010	ADC12
SZ-016A	ADC12
SZ-70-B	ABS resin
SZ-020	ABS resin

※ADC12...Aluminum alloy die-cast

**LED Units**

Model	LU5-E-R	LU5-E-Y	LU5-E-G	LU5-E-B	LU5-E-C
Unit Color	●	●	●	●	○
Rated Voltage	24V DC				
Operating Voltage Range	Rated voltage ± 10% (21.6~26.4V)				
Current/Power Consumption	52mA/1.25W		42mA/1.0W		
Operating Temperature Range	-30°C~+60°C				
Mass	44g ± 10%				

● RED ● AMBER ● GREEN ● BLUE ○ CLEAR/WHITE

**BASE Units**

Model	LU5-02	LU5-02FB
Color	○	●
Standard Body/Short Body	Standard	
Rated Voltage	24V DC	
Operating Voltage Range	Rated voltage ± 10% (21.6~26.4V)	
Buzzer		*Buzzer 1    *Buzzer 2
Current Consumption		50 ± 10mA    24 ± 10mA
Power Consumption		1.2 ± 0.25W    0.58 ± 0.25W
Sound Level		Max: 85 ± 5dB (at 1m)
Flashing Cycle		60 ± 12 flashes per minutes
Operating Temperature	-30°C~+60°C	
Range	Upright, indoor only	
Mounting Direction	IP65	
Protection Rating	182g ± 10%	200g ± 10%
Mass	PNP/NPN	

**Open Collector**  
 \* Buzzer 1 : Continuous Sound    \*\*Buzzer 2 : Intermittent Sound

○ Ivory White    ● Silver Color(U)

Optional Parts

Optional Parts

**Upper Bracket**  
 SZ-60NPT (for 1/2" NPT Pole)

**Upper Bracket**  
 SZ-60-U

**Pole**

Height  
 21.7mm

Steel Pole			
Model	POLE-800S21	POLE-300S21	POLE-100S21
Height	800mm	300mm	100mm

Aluminum Pole			
Model	POLE-800A21	POLE-300A21	POLE-100A21
Height	800mm	300mm	100mm

**Mounting Bracket**  
 SZ-016A (For φ21.7mm Pole)    SZ-70-B (For φ21.7mm Aluminum Pole Only)

**Wall Mount Bracket**  
 SZ-020 (For φ21.7mm Pole)    SZ-017 (For φ21.7mm Pole)